

GONAL-f[®] PEN

Recombinant human follicle stimulating hormone (follitropin alfa [rch])

Consumer Medicine Information

What is in this leaflet

This leaflet answers some common questions about GONAL-f.

It does not contain all the available information.

It does not take the place of talking to your doctor or nurse or pharmacist.

All medicines have risks and benefits. Your doctor has weighed the risks of you using GONAL-f against the benefits it will have for you.

If you have any concerns about using this medicine, ask your doctor, nurse or pharmacist.

GONAL-f is available only on a doctor's prescription.

Keep this information with your medicine. You may want to read it again later.

What is GONAL-f used for

GONAL-f contains follitropin alfa, which is similar to follicle stimulating hormone (FSH) found naturally in humans.

GONAL-f belongs to a class of hormones called gonadotrophins. FSH is necessary in the growth and development of egg cells (follicles) in women and sperm production in men.

In women

GONAL-f can be used to bring about the development of follicles in women who are not ovulating and who have not responded to treatment with clomiphene citrate.

GONAL-f is also used to stimulate the development of several follicles in women undergoing assisted reproductive technologies (ART) such as *in vitro* fertilisation (IVF).

In men

GONAL-f is used in combination with human chorionic gonadotrophin (hCG) to stimulate the production of sperm.

Before you use GONAL-f

When you must not use GONAL-f

Do not use GONAL-f if:

- you have history of allergy to any of the ingredients listed at the end of this leaflet
- tumour of the hypothalamus or pituitary gland

For women

Do not use GONAL-f if:

- you are pregnant
- you are breastfeeding
- your ovaries are enlarged
- you have an ovarian cyst
- you have unexplained vaginal bleeding
- you have fibroids of the

uterus that would prevent you maintaining a pregnancy

- your ovaries have failed
- you have cancer of the reproductive organs or breast

For men

Do not use GONAL-f if:

- you have an increased levels of gonadotrophins indicating failure of the testes
- your infertility is due to disorders, other than hypogonadotrophic hypogonadism (low levels of gonadotrophins)

Do not use GONAL-f if the packaging is torn or shows signs of tampering, or the product does not look quite right.

Do not use GONAL-f after the expiry date (month/year) on the packaging has passed.

If you use this medicine after the expiry date has passed, it may not work.

If it has expired or is damaged, return it to your pharmacist/clinic for disposal.

If you are not sure about using GONAL-f talk to your doctor.

Before you start to use GONAL-f

You and your partner's fertility should be assessed to see if treatment with GONAL-

f is appropriate for you.

Tell your doctor if you are breastfeeding or intend to breastfeed.

Tell your doctor if you have any allergies to:

- other medicines
- other substances such as foods, preservatives or dyes

Tell your doctor if you have or have had any other medical conditions, especially the following:

- thyroid disorders
- adrenal glands disorders
- high prolactin levels in the blood
- cancer of the pituitary or hypothalamus

Treatment with GONAL-f and hCG may increase the risk of blood clots forming in your blood vessels. Discuss this with your doctor especially if you or your family have or have had experienced the signs of blood clots (pain, warmth, redness, numbness or tingling in your arm or leg).

If you have any of the above, tell your doctor before you start to use GONAL-f.

Taking other medicines

Tell your doctor if you are taking any other medicines, including any that you buy without prescription from your pharmacy, supermarket or health food shop. Your doctor has more information on medicines to be careful with or avoid while using GONAL-f.

How GONAL-f is given

GONAL-f is given as a subcutaneous (under the skin) injection in the stomach or thigh.

The injection site should be changed daily to lessen possible injection site reactions.

If your doctor or nurse decides you can give the injections yourself, the doctor or nurse will teach you the injection technique. Do not self-inject until you are sure of how to do it.

Follow all instructions given to you by your doctor carefully.

Please see the end of this leaflet for instructions on how to administer the dose using the pre-filled pen.

How much to inject

The following is a guide to the usual dose. Your doctor may adjust your dose of GONAL-f depending on your individual response to treatment. Please consult your doctor if you are in any doubt.

1. Women who are not ovulating

The dose usually starts at 75-150 IU (5.46 to 10.92 microgram) daily. This may be gradually increased by 37.5 IU (2.73 microgram) until adequate response to treatment is obtained. The maximal daily dose is usually not higher than 225 IU (16.5 microgram).

Once you have responded, an hCG injection (to stimulate ovulation) is given 24-48 hours after the last GONAL-f injection. You are recommended to have sexual intercourse on the day of, and the day following the hCG injection.

2. Women undergoing assisted reproductive technologies

The dose usually starts at 150-225 IU (10.92 microgram to 16.5 microgram) daily, commencing on day 2 or 3 of the cycle. The dose may be adjusted according to your response. The maximal daily dose is usually not higher than 450 IU (32.76 microgram).

Once you have responded, a hCG injection is given 24-48 hours after the last GONAL-f injection.

3. Men with hypogonadotropic hypogonadism

Treatment usually begins with hCG only. If an adequate response is not obtained with hCG, your doctor may decide to give you a combination of hCG and GONAL-f 150 IU (10.92 microgram) three times a week.

Have your injections at the same time each day.

How long to use GONAL-f for

For women

The length of treatment varies with each patient. It is possible to have more than one treatment cycle of GONAL-f.

For men

The combination treatment of GONAL-f and hCG could continue for at least 4 months and may continue for up to 18-24 months.

If you forget to use GONAL-f

If you forget an injection or are not sure what to do contact your doctor or nurse immediately for advice. Do not double the dose on any day.

If you inject too much

Immediately contact your doctor or the Poisons Information Centre (In Australia telephone 131 126. In New Zealand telephone 0800 764 766) if you are concerned that you have given yourself too much GONAL-f.

While you are using GONAL-f

Your doctor may monitor your response to GONAL-f by using ultrasound, blood tests or semen analysis.

Things you must do

You are required to see your doctor regularly so you can be monitored closely throughout your treatment. If you are about to be started on any new medicine, tell your doctor and pharmacist that you are using GONAL-f.

If you plan to have surgery, tell your doctor or dentist that you are using GONAL-f.

Tell all doctors, dentists and pharmacists who are treating you that you are using GONAL-f.

For Women

Tell your doctor immediately if you become pregnant while using GONAL-f.

Things you must not do

If you are self-injecting **do not:**

- stop using GONAL-f without telling your doctor.
- change the dose unless your doctor tells you to. Changing your dose without advising your doctor can increase your risk of unwanted side effects or can prevent the drug from working properly.
- give this medicine to anyone else, even if their symptoms seem similar to yours or if they have the same condition as you.

Things to be careful of

For Women

- treatment with GONAL-f and hCG may increase your risk of multiple pregnancies or births
- Ovarian Hyperstimulation Syndrome (OHSS) – may occur (see side effects)

To minimise this risk, your doctor may monitor your treatment with regular ultrasounds and blood tests.

GONAL-f does not interfere with your ability to drive a car or operate machinery.

SIDE EFFECTS

Tell your doctor as soon as possible if you do not feel well while using GONAL-f. All medicines can have side effects. Sometimes they are serious, most of the time they are not.

If you get any side effects, do not stop using GONAL-f without first talking to your doctor.

Tell your doctor if you notice pain, redness, itching or swelling at the site of injection

during your treatment with GONAL-f.

However, should you notice any of the following side effects contact your doctor immediately or go to the accident and emergency section of your nearest hospital:

- swelling of the face, lips, tongue, or other parts of the body
- shortness of breath, wheezing or difficulty breathing
- skin rash, itching or hives

For women

Tell your doctor if you notice any of the following:

- headache, dizziness
- stomach cramps, pain or discomfort
- nausea, vomiting
- diarrhoea
- breast tenderness
- hair loss, dry skin
- ovarian enlargement, bloating

These are common side effects.

If any of the following happen, stop using GONAL-f, contact your doctor immediately or go to the accident and emergency section of your nearest hospital:

- inflammation, swelling or clotting of the blood vessels
- severe pelvic pain, nausea and vomiting and weight gain, these are early warnings of OHSS

Other side effects associated with OHSS are:

- severe enlargement of the ovaries, indigestion, diarrhoea, reduced amounts of urine, weight gain, shortness of breath

Ectopic pregnancy (embryo implanted outside the womb) may occur after treatment with GONAL-f. This is a rare side effect.

For men

Tell your doctor if you notice any of the following:

- acne
- some breast development
- weight gain

These are common side effects.

Other side effects not listed above may also occur in some patients. Tell your doctor if you notice anything else that is making you feel unwell.

Do not be alarmed by this list of possible side effects. You may not experience any of them.

After Using GONAL-f

Storage

Prior to using, store GONAL-f PEN at 2°C to 8°C (Refrigerate. Do not Freeze). Should refrigeration be unavailable, the GONAL-f PEN can be stored below 25°C for up to 3 months and away from light.

After first piercing the GONAL-f PEN with a needle, GONAL-f PEN may be stored below 25°C for a maximum of 21 days with the cap on, in order to protect the product from light.

Do not use GONAL-f PEN solution if it contains particles or is not clear.

Do not store GONAL-f in the bathroom or near a sink.

Do not leave GONAL-f in the car.

Keep GONAL-f where children cannot reach it.

Disposal

If you are self-injecting, you should discard all sharps into a disposal unit.

If you have any GONAL-f that has expired or is left over from your treatment refer this to your clinic.

Product description

What it looks like

GONAL-f PEN is pre-filled and available as solution for injection in three strengths of 300 IU (21.84 microgram), 450 IU (32.76 microgram) and 900 IU (65.52 microgram).

GONAL-f PEN is pre-filled with a clear, colourless solution of 0.5 mL (300 IU), 0.75 mL (450 IU) or 1.5 mL (900 IU).

Each cartridge contains the following ingredients:

Active ingredient

- Follitropin alfa
300 IU (21.84 microgram), 450 IU (32.76 microgram) and 900 IU (65.52 microgram)

Other ingredients –

- Sucrose
- Sodium phosphate - dibasic dihydrate
- Sodium phosphate - monobasic
- Sodium hydroxide
- Phosphoric acid
- Poloxamer
- Methionine
- m-cresol
- Water for Injections

GONAL-f 300 IU/0.5 mL (21.84 microgram/0.5 mL)

PEN is supplied in packs of: 1 cartridge pre-assembled in a disposable pen and 8 needles for administration.

GONAL-f 450 IU/0.75 mL (32.76 microgram/0.75 mL)

PEN is supplied in packs of: 1 cartridge pre-assembled in a disposable pen and 12 needles for administration.

GONAL-f 900 IU/1.5 mL (65.52 microgram/1.5 mL)

PEN is supplied in packs of: 1 cartridge pre-assembled in a disposable pen and 20 needles for administration.

Australian Registration Numbers:

GONAL-f 300 IU PEN for injection AUST R 96230

GONAL-f 450 IU PEN for injection AUST R 96236

GONAL-f 900 IU PEN for injection AUST R 96237

GONAL-f PEN is supplied in Australia by:

Merck Serono Australia Pty Ltd
3-4/25 Frenchs Forest Road
Frenchs Forest NSW 2086

For enquiries call:
1800 633 463

GONAL-f PEN is supplied in New Zealand by:

Healthcare Logistics
58 Richard Pearse Drive
Airport Oaks, Auckland

This leaflet was prepared in September 2010

HOW TO USE THE GONAL-f PRE-FILLED PEN

- This section tells you how to use your pen.
- Before starting to use your pen, please read these instructions the whole way through first.
- Only use this pen for you – do not let anyone else use it.
- The numbers on the dose display are measured in International Units or IU. Your doctor will have advised you how many IU to inject each day.
- Give yourself the injection at the same time each day.

Before you start using the pre-filled pen

1. Wash your hands

- It is important that your hands and the things you use to get your pen ready are as clean as possible.

2. Find a clean area

- A good place is a clean table or kitchen surface.

3. Get together everything you need and lay them out:

- 2 alcohol swabs
- the pre-filled pen
- a needle

Below is a diagram that shows what the pre-filled pen looks like along with the labels of the components:

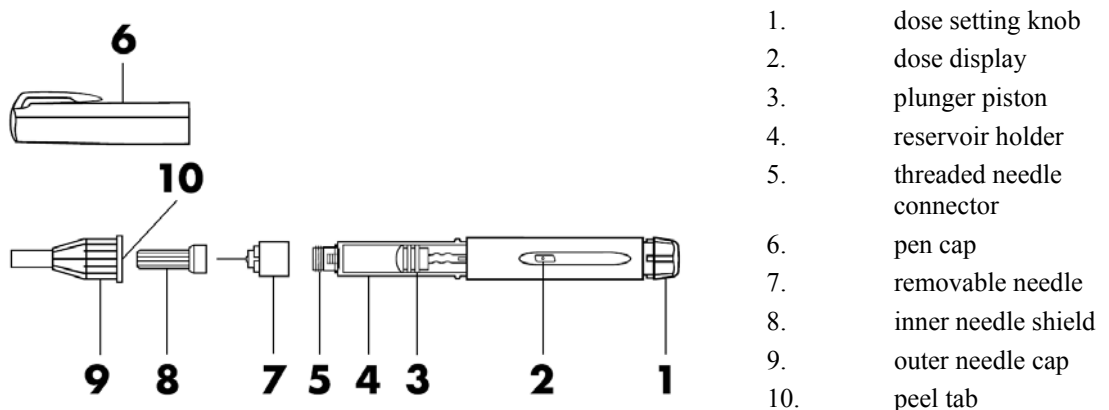

Please note: The scale that can be seen through the reservoir holder shows how much of the medicine is left in the pen. **Do not use it to set the dose.**

Setting a pre-filled pen ready for injection

1. Take off the pen cap

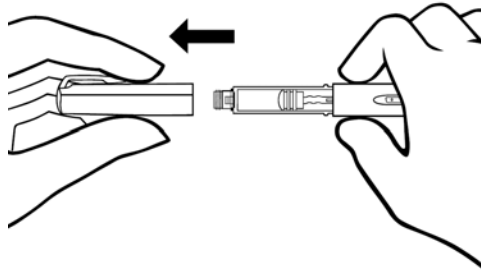

2. Put on a needle

- Take a new needle – only use the ‘single-use’ needles supplied for the GONAL-f pre-filled pen.
- Check that the peel-off seal on the outer needle cap is not damaged or loose. If it is damaged or loose, do not use the needle and get another. Throw away the unused needle with the outer needle cap still on; ask your pharmacist how to dispose of needles that are no longer required.
- Pull off the peel-off seal.
- Hold the outer needle cap firmly.
- Press the threaded tip of the pen into the outer needle cap and twist it clockwise.

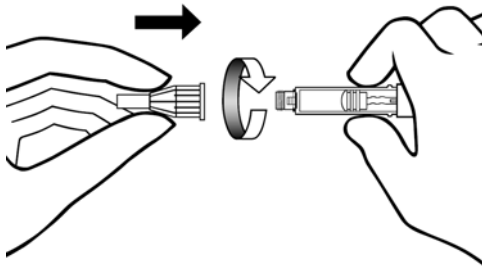

- Twist it until it is firmly fixed.
- Remove the outer needle cap by pulling it gently. Leave the inner needle shield in position.
- Do not throw away the outer needle cap; you will need it for removing the needle from the pre-filled pen.

3. Getting the pre-filled pen ready for first use

- Look carefully at the reservoir holder.
- **If you do not notice a large air bubble, the pre-filled pen is ready for use. Please go straight to step “Setting the dose”.**
- If you see a large air bubble inside the reservoir you need to remove it. An air bubble is large if it fills fully the tip of the reservoir when holding the pre-filled pen with the needle pointing upwards. **Small air bubbles that stick to the inner wall of the reservoir do not need to be removed.**
- To remove a large air bubble:
 - Gently turn the dose setting knob clockwise until it reads 25 IU preceded by a dot (●) in the dose display. If you pass this position, simply turn the dose setting knob back to the reading 25 and dot (●).
 - Then take off the inner needle cap and hold the pen with the needle pointing upwards.

- Tap the liquid holder gently with your finger so that any air bubbles rise up towards the needle.
- With the needle still pointing upwards, press slowly the dose setting knob as far as it will go. A drop of liquid must appear at the tip of the needle; this shows that your pen is ready for injection. The amount of liquid seen at the needle tip is just the 'over-fill' from the pre-filled pen (generally less than 37.5 IU).
- Now go to the step "Setting the dose".

Setting the dose

1. Gently turn the dose setting knob clockwise until you can read your dose through the dose display. Do not push or pull the dose setting knob while you turn it.

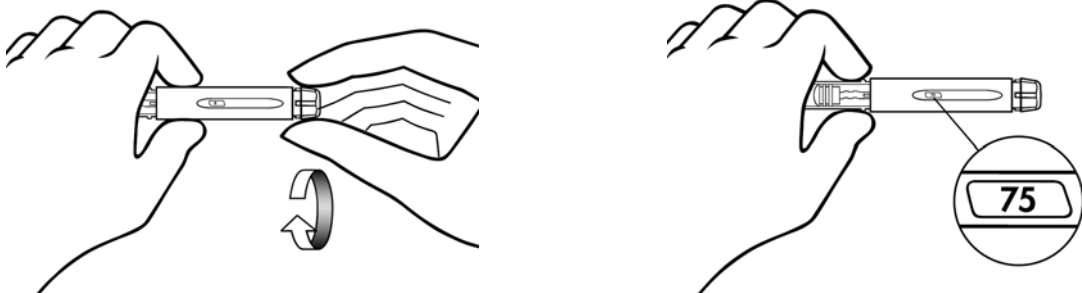

2. If you pass your dose simply turn the dose setting knob back to the correct dose. To adjust the dose, you can turn the dose dial either clockwise or counter-clockwise. **CAUTION:** You should set the dose as you were advised by your doctor.

Injecting the dose

1. **Prepare the place to give the injection** – where your doctor or nurse has advised you (except around the navel and waistline). To minimise skin irritation, select a different injection site each day.
2. **Clean the skin where you will inject by wiping the area with an alcohol swab.**
3. **Check again the dose shown in the dose display. If it is not the correct dose, you must adjust it by turning the dose setting knob either clockwise or counter-clockwise (see step "Setting the dose").**
4. **If not already done in step "Getting the pen ready for first use", remove carefully the inner needle shield and throw it away.**
5. **Inject the dose as you were advised by your doctor or nurse.**
 - Slowly insert the needle into the skin and press the dose setting knob as far as it will go.

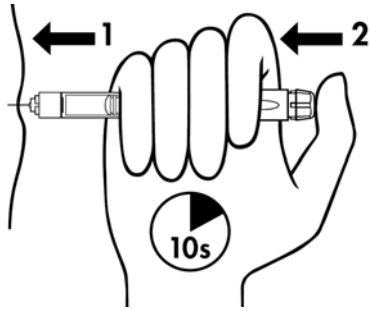

- You must keep the needle in the skin **with the dose setting knob pressed down** for at least 10 seconds.
- The dose number shown in the dose display will turn back to 0. This indicates that the complete dose was delivered. See step “Making sure you have given a complete injection” for details.
- After 10 seconds, keep the dose setting knob pressed down, and withdraw the needle out of the skin.

After the injection

1. Making sure you have given a complete injection.

- Check that the dose display shows 0. This confirms that the dose has been completed correctly.

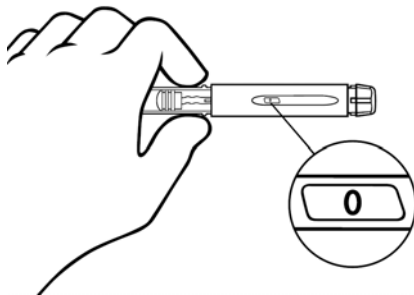

- **CAUTION:** If the dose display shows a number higher than 0, this indicates that the pre-filled pen is empty and that the complete dose has not been given. If this happens:
 - The number shown in the dose display indicates **the missing amount** of GONAL-f solution to complete your dose. This is the dose you need to inject using a new pre-filled pen.
 - To complete your dose, follow all the steps described above. After preparing the pen as described in the step “Before you start” through to the step “Getting the pen ready for first use” above, **set the dose to the missing amount displayed on the empty pen that you have just finished** and inject this amount.

2. Taking off the needle

- Take off the needle after each injection.
 - Hold the pen firmly by the liquid holder.
 - Carefully put back the outer needle cap onto the needle.

- Then grip the outer needle cap and unscrew the needle – do this by turning anti-clockwise.
- Dispose of the used needle safely; ask your pharmacist how to dispose of needles that are no longer required.
- Be careful not to sting yourself with the needle.
- Now put the pen cap back onto the pen.
- Never reuse any used needle. Never share needles.

CAUTION: Always remove the needle from the pre-filled pen before putting the pen cap on. Never store the pen with the needle still attached. The pen cap can not fit over a pre-filled pen with a needle attached.

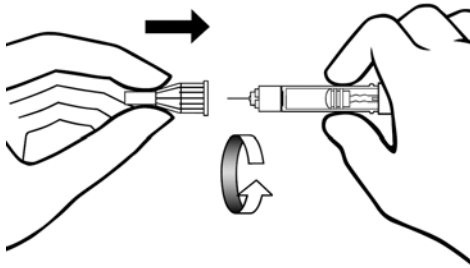

3. Storing the pen

- Store the pen in a safe place.
 - It is best to put it back into its original package (see also the information described in the Storage section of the CMI). When the pen is empty, ask your pharmacist how to dispose of medicines that are no longer required.