

# NEW ZEALAND DATA SHEET – SMOFKABIVEN NTENSE® (AMINO ACIDS 6.5%, ELECTROLYTES 0.7%, LIPIDS 2.9% and GLUCOSE 8.5%)

## 1. PRODUCT NAME

SmofKabiven NTense® (Amino acids 6.5%, Electrolytes 0.7%, Lipids 2.9%, and Glucose 8.5%). Emulsion for intravenous infusion.

## 2. QUALITATIVE AND QUANTITATIVE COMPOSITION

SmofKabiven NTense® consists of a three chamber bag system. Each bag contains the following partial volumes depending on the five pack sizes.

	506 mL	1012 mL	1518 mL	2025 mL	2531 mL	Per 1000 mL
Amino acid solution 10% with electrolytes	331 mL	662 mL	993 mL	1325 mL	1656 mL	654 mL
Glucose solution 42%	102 mL	204 mL	306 mL	408 mL	510 mL	202 mL
Lipid emulsion 20%	73 mL	146 mL	219 mL	292 mL	365 mL	144 mL

This corresponds to the following total compositions:

Active Ingredients	506 mL	1012 mL	1518 mL	2025 mL	2531 mL	Per 1000 mL
Alanine	4.6 g	9.3 g	14 g	19 g	23 g	9.2 g
Arginine	4.0 g	7.9 g	12 g	16 g	20 g	7.9 g
Glycine	3.6 g	7.3 g	11 g	15 g	18 g	7.2 g
Histidine	1.0 g	2.0 g	3.0 g	4.0 g	5.0 g	2.0 g
Isoleucine	1.7 g	3.3 g	5.0 g	6.6 g	8.3 g	3.3 g
Leucine	2.4 g	4.9 g	7.3 g	9.8 g	12 g	4.8 g
Lysine (as acetate)	2.2 g	4.4 g	6.6 g	8.7 g	11 g	4.3 g
Methionine	1.4 g	2.8 g	4.3 g	5.7 g	7.1 g	2.8 g
Phenylalanine	1.7 g	3.4 g	5.1 g	6.8 g	8.4 g	3.3 g
Proline	3.7 g	7.4 g	11 g	15 g	19 g	7.3 g
Serine	2.2 g	4.3 g	6.5 g	8.6 g	11 g	4.3 g
Taurine	0.33 g	0.66 g	1.0 g	1.3 g	1.7 g	0.65 g
Threonine	1.5 g	2.9 g	4.4 g	5.8 g	7.3 g	2.9 g
Tryptophan	0.66 g	1.3 g	2.0 g	2.7 g	3.3 g	1.3 g
Tyrosine	0.13 g	0.26 g	0.40 g	0.53 g	0.66 g	0.26 g
Valine	2.1 g	4.1 g	6.2 g	8.2 g	10 g	4.1 g
Calcium chloride dihydrate <i>corresponding to</i> Calcium chloride	0.14 g	0.29 g	0.43 g	0.58 g	0.72 g	0.28 g
Sodium glycerophosphate hydrate <i>corresponding to</i> Sodium glycerophosphate	1.2 g	2.3 g	3.5 g	4.6 g	5.8 g	2.3 g
Magnesium sulfate heptahydrate <i>corresponding to</i> Magnesium sulfate	0.31 g	0.62 g	0.92 g	1.2 g	1.5 g	0.61 g
Potassium chloride	1.2 g	2.3 g	3.5 g	4.6 g	5.8 g	2.3 g

## NEW ZEALAND DATA SHEET – SMOFKABIVEN NTENSE® (AMINO ACIDS 6.5%, ELECTROLYTES 0.7%, LIPIDS 2.9% and GLUCOSE 8.5%)

Active Ingredients	506 mL	1012 mL	1518 mL	2025 mL	2531 mL	Per 1000 mL
Sodium acetate trihydrate <i>corresponding to</i> Sodium acetate	0.82 g	1.6 g	2.5 g	3.3 g	4.1 g	1.6 g
Zinc sulfate heptahydrate <i>corresponding to</i> Zinc sulfate	0.0033 g	0.0066 g	0.010 g	0.013 g	0.017 g	0.0066 g
Glucose monohydrate <i>corresponding to</i> Glucose	43 g	86 g	129 g	171 g	214 g	85 g
Soya oil	4.4 g	8.8 g	13 g	18 g	22 g	8.7 g
Medium-chain triglycerides	4.4 g	8.8 g	13 g	18 g	22 g	8.7 g
Olive oil	3.7 g	7.3 g	11 g	15 g	18 g	7.2 g
Fish oil - rich in Omega-3-acids	2.2 g	4.4 g	6.6 g	8.8 g	11 g	4.3 g

Corresponding to:

	506 mL	1012 mL	1518 mL	2025 mL	2531 mL	Per 1000 mL
Amino acids	33.1 g	66.3 g	99.4 g	133 g	166 g	65.5 g
Nitrogen	5.3 g	10.6 g	15.9 g	21.2 g	26.5 g	10.5 g
Electrolytes						
- sodium	20.6 mmol	41.3 mmol	61.9 mmol	82.6 mmol	103 mmol	40.8 mmol
- potassium	15.5 mmol	30.9 mmol	46.4 mmol	61.9 mmol	77.3 mmol	30.5 mmol
- magnesium	2.6 mmol	5.2 mmol	7.7 mmol	10.3 mmol	12.9 mmol	5.1 mmol
- calcium	1.3 mmol	2.6 mmol	3.9 mmol	5.2 mmol	6.5 mmol	2.6 mmol
- phosphate <sup>1</sup>	6.4 mmol	12.9 mmol	19.3 mmol	25.8 mmol	32.2 mmol	12.7 mmol
- zinc	0.02 mmol	0.04 mmol	0.06 mmol	0.08 mmol	0.10 mmol	0.04 mmol
- sulfate	2.6 mmol	5.2 mmol	7.8 mmol	10.4 mmol	13.0 mmol	5.1 mmol
- chloride	18.0 mmol	36.1 mmol	54.1 mmol	72.2 mmol	90.2 mmol	35.6 mmol
- acetate	63.1 mmol	126 mmol	189 mmol	253 mmol	316 mmol	125 mmol
Carbohydrates						
- Glucose	42.8 g	85.7 g	129 g	171 g	214 g	84.7 g
Lipids	14.6 g	29.2 g	43.8 g	58.4 g	73.0 g	28.9 g
Energy content						
- total (approx.)	450 kcal 1.9 MJ	900 kcal 3.8 MJ	1350 kcal 5.6 MJ	1800 kcal 7.5 MJ	2250 kcal 9.4 MJ	889 kcal 3.7 MJ
- non-protein (approx.)	317 kcal 1.3 MJ	635 kcal 2.7 MJ	952 kcal 4.0 MJ	1270 kcal 5.3 MJ	1590 kcal 6.6 MJ	627 kcal 2.6 MJ

<sup>1</sup> Contribution from both the lipid emulsion and the amino acid solution.

For the full list of excipients, see Section 6.1 List of excipients.

### 3. PHARMACEUTICAL FORM

Emulsion for intravenous infusion.

Glucose and amino acid solutions are clear and colourless to slightly yellow and free from particles.

# **NEW ZEALAND DATA SHEET – SMOFKABIVEN NTENSE® (AMINO ACIDS 6.5%, ELECTROLYTES 0.7%, LIPIDS 2.9% and GLUCOSE 8.5%)**

---

The lipid emulsion is white and homogenous.

Osmolality: Approx. 1600 mosmol/kg water

Osmolarity: Approx. 1300 mosmol/L

pH (after mixing): Approx. 5.6

## **4. CLINICAL PARTICULARS**

### **4.1 Therapeutic Indications**

Parenteral nutrition for adult patients and paediatric patients aged 2 years and above when oral or enteral nutrition is impossible, insufficient or contraindicated.

### **4.2 Dose and Method of Administration**

#### Dosage (Dose and Interval)

The appearance of the product after mixing the 3 chambers is a white emulsion.

The patient's ability to eliminate lipids and metabolise nitrogen and glucose, and the nutritional requirements should govern the dosage and infusion rate, see section 4.4 Special warnings and precautions for use.

The dose should be individualised to the patient's clinical condition, body weight (bw), nutritional and energy requirements, adjusting dosage based upon additional oral/enteral intake.

The nitrogen requirements for maintenance of body protein mass depend on the patient's condition (e.g. nutritional state and degree of catabolic stress or anabolism).

#### **ADULTS**

The requirements are 0.10-0.15 g nitrogen/kg bw/day (0.6-0.9 g amino acids/kg bw/day) in the normal nutritional state or in conditions with mild catabolic stress. In patients with moderate to high metabolic stress with or without malnutrition, the requirements are in the range of 0.15-0.25 g nitrogen/kg bw/day (0.9-1.6 g amino acids/kg bw/day). In some very special conditions (e.g. burns or marked anabolism) the nitrogen need may be even higher.

#### *Dosage:*

The dosage range of 13-31 mL SmofKabiven NTense®/kg-bw/day corresponds to 0.14-0.32 g nitrogen/kg bw/day (0.85-2.0 g amino acids/kg bw/day) and 12-28 kcal/kg bw/day of total energy (8-19 kcal/kg bw/day of non-protein energy). This covers the need of the majority of the patients. In obese patients the dose should be based on the estimated ideal weight.

#### *Infusion Rate:*

The maximum infusion rate for glucose is 0.25 g/kg bw/h, for amino acid 0.1 g/kg bw/h, and for lipids 0.15 g/kg bw/h.

The infusion rate should not exceed 1.5 mL/kg bw/h (corresponding to 0.13 g glucose, 0.10 g amino acids, and 0.04 g lipids/kg bw/h). The recommended infusion period is 14-24 hours.

# **NEW ZEALAND DATA SHEET – SMOFKABIVEN NTENSE® (AMINO ACIDS 6.5%, ELECTROLYTES 0.7%, LIPIDS 2.9% and GLUCOSE 8.5%)**

---

## *Maximum Daily Dose:*

The maximum daily dose varies with the clinical condition of the patient and may even change from day to day. The recommended maximum daily dose is 31 mL/kg bw/day.

The recommended maximum daily dose of 31 mL/kg bw/day will provide 2.0 g amino acids/kg bw/day (corresponding to 0.32 g nitrogen/kg bw/day), 2.6 g glucose/kg bw/day, 0.9 g lipids/kg bw/day and a total energy content of 28 kcal/kg bw/day (corresponding to 19 kcal/kg-bw/day of non-protein energy).

## **PAEDIATRIC POPULATION**

### **Children (2-11 years)**

#### *Dosage:*

The dose up to 31 mL/kg bw/day should be regularly adjusted to the requirements of the paediatric patient that varies more than in adult patients.

#### *Infusion Rate:*

The recommended maximum infusion rate is 1.8 mL/kg bw/h (corresponding to 0.12 g amino acids/kg/h, 0.15 g/glucose/kg/h and 0.05 g lipids/kg/h). At the recommended maximum infusion rate, do not use an infusion period longer than 17 hours, except in exceptional cases and with careful monitoring.

The recommended infusion period is 12-24 hours.

#### *Maximum Daily Dose:*

The maximum daily dose varies with the clinical condition of the patient and may even change from day to day. The recommended maximum daily dose is 31 mL/kg bw/day.

The recommended maximum daily dose of 31 mL/kg bw/day will provide 2 g amino acids/kg bw/day (corresponding to 0.32 g nitrogen/kg bw/day), 2.6 g glucose/kg bw/day, 0.9 g lipids/kg bw/day and a total energy content of 28 kcal/kg bw/day (corresponding to 19 kcal/kg bw/day of non-protein energy).

### **Adolescents (12-17 years)**

In adolescents, SmofKabiven NTense® can be used as in adults.

#### Method of Administration

Intravenous use, infusion into a central vein.

The five different package sizes of SmofKabvien NTense are intended for patients with high, moderately increased or basal nutritional requirements. To provide total parenteral nutrition, trace elements, vitamins and possibly electrolytes (taking into account the electrolytes already present in SmofKabiven NTense®) should be added to SmofKabiven NTense® according to the patients need.

For instructions on preparation of the medicinal product before administration, see section 6.6 Special precautions for disposal and handling.

# NEW ZEALAND DATA SHEET – SMOFKABIVEN NTENSE® (AMINO ACIDS 6.5%, ELECTROLYTES 0.7%, LIPIDS 2.9% and GLUCOSE 8.5%)

## Compatibility

Compatibility data are available with the named branded products Dipeptiven, Addaven, Vitalipid N Adult and Soluvit N (lyophilized) in defined amounts and generics of electrolytes in defined concentrations. When making electrolyte additions, the amounts already present in the bag should be taken into account to meet the clinical needs of the patient. Generated data supports additions to the activated bag according to the summary table below.

	<b>Maximal Total Contents</b>	
SmofKabiven NTense® bag size	1012 mL, 1518 mL, 2025 mL and 2531 mL	506 mL
<b>Additive</b>	<b>Volume</b>	
Dipeptiven	0 - 300 mL	0 - 150 mL
Addaven	0 - 20 mL	0 - 10 mL
Soluvit N (lyophilized)	0 - 2 vials	0 - 1 vial
Vitalipid N Adult	0 - 20 mL	0 - 10 mL
	<b>Concentration</b>	
Sodium	0 - 150 mmol/L	0 - 150 mmol/L
Potassium	0 - 150 mmol/L	0 - 150 mmol/L
Calcium	0 - 5 mmol/L	0 - 5 mmol/L
Magnesium	0 - 5 mmol/L	0 - 5 mmol/L
Phosphate (Addiphos) OR Phosphate (Glycophos)	0 - 15 mmol/L 0 - 30 mmol/L	0 - 15 mmol/L 0 - 30 mmol/L
Zinc	0 - 0.2 mmol/L	0 - 0.2 mmol/L
Selenium	0 - 2 µmol/L	0 - 2 µmol/L

Note: This table is intended to indicate compatibility. It is not a dosing guideline.

### 4.3 Contraindications

- Hypersensitivity to fish-, egg-, soya- or peanut protein or to any of the active substances or excipients listed in section 6.1 List of excipients.
- Severe hyperlipidaemia
- Severe liver insufficiency
- Severe blood coagulation disorders
- Congenital errors of amino acid metabolism
- Severe renal insufficiency without access to haemofiltration or dialysis
- Acute shock
- Uncontrolled hyperglycaemia
- Pathologically elevated serum levels of any of the included electrolytes
- General contraindications to infusion therapy: acute pulmonary oedema, hyperhydration, and decompensated cardiac insufficiency
- Haemophagocytotic syndrome
- Unstable conditions (e.g. severe post-traumatic conditions, uncompensated diabetes mellitus, acute myocardial infarction, stroke, embolism, metabolic acidosis, severe sepsis, hypotonic dehydration and hyperosmolar coma)
- Neonates and infants under 2 years of age

# **NEW ZEALAND DATA SHEET – SMOFKABIVEN NTENSE® (AMINO ACIDS 6.5%, ELECTROLYTES 0.7%, LIPIDS 2.9% and GLUCOSE 8.5%)**

---

## **4.4 Special Warnings and Precautions for Use**

### Identified Precautions

The capacity to eliminate lipids is individual and should therefore be monitored according to the routines of the clinician. This is in general done by checking the triglyceride levels. The concentration of triglycerides in serum should not exceed 4 mmol/L during infusion. An overdose may lead to fat overload syndrome, see section 4.8 Undesirable effects.

SmofKabiven NTense® should be given with caution in conditions of impaired lipid metabolism, which may occur in patients with renal failure, diabetes mellitus, pancreatitis, impaired liver function, hypothyroidism and sepsis.

This medicinal product contains soya oil, fish oil and egg lecithin, which may rarely cause allergic reactions. Cross allergic reaction has been observed between soya-bean and peanut.

To avoid risks associated with too rapid infusion rates, it is recommended to use a continuous and well-controlled infusion, if possible by using a volumetric pump.

Disturbances of the electrolyte and fluid balance (e.g. abnormally high or low serum levels of the electrolytes) should be corrected before starting the infusion.

SmofKabiven NTense® should be given with caution to patients with a tendency towards electrolyte retention. Special clinical monitoring is required at the beginning of any intravenous infusion. Should any abnormal sign occur, the infusion must be stopped.

Since an increased risk of infection is associated with the use of any central vein, strict aseptic precautions should be taken to avoid any contamination during catheter insertion and manipulation.

Serum glucose, electrolytes and osmolarity as well as fluid balance, acid-base status and liver enzyme tests should be monitored.

Blood cell count and coagulation should be monitored when lipids are given for a longer period.

In patients with renal insufficiency, the phosphate and potassium intake should be carefully controlled to prevent hyperphosphatemia and hyperkalaemia.

The amount of individual electrolytes to be added is governed by the clinical condition of the patient and by frequent monitoring of serum levels.

Parenteral nutrition should be given with caution in lactic acidosis, insufficient cellular oxygen supply and increased serum osmolarity.

Any sign or symptom of anaphylactic reaction (such as fever, shivering, rash or dyspnoea) should lead to immediate interruption of the infusion.

Intravenous infusion of amino acids is accompanied by increased urinary excretion of the trace elements, in particular copper and zinc. This should be considered in the dosing of trace elements,

## **NEW ZEALAND DATA SHEET – SMOFKABIVEN NTENSE® (AMINO ACIDS 6.5%, ELECTROLYTES 0.7%, LIPIDS 2.9% and GLUCOSE 8.5%)**

---

especially during long-term intravenous nutrition. Amounts of zinc administered with SmofKabiven NTense® should be taken into account.

In malnourished patients, initiation of parenteral nutrition can precipitate fluid shifts resulting in pulmonary oedema and congestive heart failure as well as a decrease in the serum concentration of potassium, phosphorus, magnesium and water-soluble vitamins. These changes can occur within 24 to 48 hours, therefore careful and slow initiation of parenteral nutrition is recommended in this patient group, together with close monitoring and appropriate adjustments of fluid, electrolytes, minerals and vitamins.

SmofKabiven NTense® should not be given simultaneously with blood in the same infusion set due to the risk of pseudo-agglutination.

In patients with hyperglycaemia, administration of exogenous insulin might be necessary. Amino acid solutions may precipitate acute folate deficiency; folic acid should therefore be given daily.

Vitamin B complex deficiency may occur with glucose administration.

Review of current available literature associated with Parenteral Nutrition Associated Liver Dysfunction (PNALD) shows emerging evidence indicating that fish oil-based lipid emulsions improve liver function within the scope of PN in general and may have the potential to reverse PNALD in children with short bowel syndrome.

Excessive exposure to light and UV light should be avoided as peroxide formation may occur.

SmofKabiven NTense® is a preparation of complex composition. It is, therefore, strongly advisable not to add other solutions if compatibility is not proven (see section 6.2 Incompatibilities).

### Use in the Elderly

No data available.

### Paediatric Use

Due to composition of the amino acid solution in SmofKabiven NTense® it is not suitable for the use in neonates and infants below 2 years of age.

### Effects on Laboratory Tests

The fat content of SmofKabiven NTense® may interfere with certain laboratory measurements (e.g. bilirubin, lactate anhydrogenase, oxygen saturation, haemoglobin) if blood is sampled before fat has been adequately cleared from the bloodstream. Fat is cleared after a fat-free interval of 5-6 hours in most patients.

## **4.5 Interaction with Other Medicines and Other Forms of Interactions**

Some medicinal products, like insulin, may interfere with the body's lipase system. This kind of interaction seems, however, to be of limited clinical importance.

## **NEW ZEALAND DATA SHEET – SMOFKABIVEN NTENSE® (AMINO ACIDS 6.5%, ELECTROLYTES 0.7%, LIPIDS 2.9% and GLUCOSE 8.5%)**

Heparin given in clinical doses causes a transient release of lipoprotein lipase into the circulation. This may result initially in increased plasma lipolysis followed by a transient decrease in triglyceride clearance.

Soya oil has a natural content of vitamin K<sub>1</sub>. However, the concentration in SmofKabiven NTense® is so low that it is not expected to significantly influence the coagulation process in patients treated with coumarin derivatives.

### **4.6 Fertility, Pregnancy and Lactation**

#### Effects on Fertility

The potential effects of SmofKabiven NTense® on fertility and general reproductive performance have not been determined in animal studies.

#### Use in Pregnancy

As with all parenteral nutrition products, SmofKabiven NTense® is exempt from pregnancy categorisation. There are no adequate and well-controlled studies in pregnant women with SmofKabiven NTense® or its individual components; therefore, the safety of SmofKabiven NTense® in pregnant women is not known.

No animal studies have been conducted with the combined lipid components of SmofKabiven NTense® to evaluate effects on reproduction. Embryotoxicity and increased incidences of foetal skeletal variations have been observed in rabbits that had received medium chain fatty acid-containing lipids similar to those in SmofKabiven NTense® during the period of organogenesis. SmofKabiven NTense® should not be used during pregnancy unless the expected therapeutic benefit clearly outweighs the potential risk to the foetus.

#### Use in Lactation

It is not known whether SmofKabiven NTense® can enter maternal milk. As zinc is excreted in milk, there is a theoretical risk of zinc-induced copper deficiency in the infant at high doses of SmofKabiven NTense®. SmofKabiven NTense® should be used during lactation only if clearly needed.

### **4.7 Effects on Ability to Drive and Use Machines**

The effects of this medicine on a person's ability to drive and use machines were not assessed as part of its registration.

### **4.8 Undesirable Effects**

	<b>Common</b> ≥ 1/100 to < 1/10	<b>Uncommon</b> ≥ 1/1,000 to < 1/100	<b>Rare</b> ≥ 1/10,000 to < 1/1,000
<i>Cardiac disorders</i>			Tachycardia
<i>Respiratory, thoracic &amp; mediastinal disorders</i>			Dysnoea
<i>Gastrointestinal disorders</i>		Lack of appetite, nausea, vomiting	



## NEW ZEALAND DATA SHEET – SMOFKABIVEN NTENSE® (AMINO ACIDS 6.5%, ELECTROLYTES 0.7%, LIPIDS 2.9% and GLUCOSE 8.5%)

	<b>Common</b> ≥ 1/100 to < 1/10	<b>Uncommon</b> ≥ 1/1,000 to < 1/100	<b>Rare</b> ≥ 1/10,000 to < 1/1,000
<i>Metabolism &amp; nutrition disorders</i>		Elevated plasma levels of liver enzymes	
<i>Vascular disorders</i>			Hypotension, hypertension
<i>General disorders &amp; administration site conditions</i>	Slight increase in body temperature	Chills, dizziness, headache	Hypersensitivity-reactions (e.g. anaphylactic or anaphylactoid reactions, skin rash, urticaria, flush, headache), heat or cold sensation, paleness, cyanosis, pain in the neck, back, bones, chest and loins

Should these side-effects occur the infusion of SmofKabiven NTense® should be stopped or, if necessary, continued at a reduced dosage.

### Fat Overload Syndrome

Impaired capacity to eliminate triglycerides can lead to “Fat overload syndrome” which may be caused by overdose. Possible signs of metabolic overload must be observed. The cause may be genetic (individually different metabolism) or the lipid metabolism may be affected by ongoing or previous illnesses. This syndrome may also appear during severe hypertriglyceridemia, even at the recommended infusion rate, and in association with a sudden change in the patient’s clinical condition, such as renal function impairment or infection. The fat overload syndrome is characterised by hyperlipemia, fever, lipid infiltration, hepatomegaly with or without icterus, splenomegaly, anaemia, leukopenia, thrombocytopenia, coagulation disorder, haemolysis and reticulocytosis, abnormal liver function tests and coma. The symptoms are usually reversible if the infusion of the lipid emulsion is discontinued.

### Excess of Amino Acid Infusion

As with other amino acid solutions, the amino acid content in SmofKabiven NTense® may cause undesirable effects when the recommended infusion rate is exceeded. These effects are nausea, vomiting, shivering and sweating. Amino acid infusion may also cause a rise in body temperature. With an impaired renal function, increased levels of nitrogen containing metabolites (e.g. creatinine, urea) may occur.

### Excess of Glucose Infusion

If the glucose clearance capacity of the patient is exceeded, hyperglycaemia will develop.

### Reporting of Suspected Adverse Reactions

Reporting suspected adverse reactions after authorisation of the medicine is important. It allows continued monitoring of the benefit/risk balance of the medicine. Healthcare professionals are asked to report any suspected adverse reactions. <https://nzphvc.otago.ac.nz/reporting/>.

# **NEW ZEALAND DATA SHEET – SMOFKABIVEN NTENSE® (AMINO ACIDS 6.5%, ELECTROLYTES 0.7%, LIPIDS 2.9% and GLUCOSE 8.5%)**

---

## **4.9 Overdose**

See section 4.8 Undesirable effects “Fat overload syndrome”, “Excess of amino acid infusion” and “Excess of glucose infusion”.

If symptoms of overdose of lipids or amino acids occur, the infusion should be slowed down or discontinued. There is no specific antidote for overdose. Emergency procedures should be general supportive measures, with particular attention to respiratory and cardiovascular systems. Close biochemical monitoring would be essential and specific abnormalities treated appropriately.

If hyperglycaemia occurs, it should be treated according to the clinical situation either by appropriate insulin administration and/or adjustment of the infusion rate.

Additionally, overdose might cause fluid overload, electrolyte imbalances and hyperosmolality.

In some rare serious cases, haemodialysis, haemofiltration or haemodiafiltration may be considered.

For information on the management of overdose, contact the National Poisons Centre on 0800 POISON (0800 764 766).

## **5. PHARMACOLOGICAL PROPERTIES**

### **5.1 Pharmacodynamic Properties**

#### Mechanism of Action

#### **Lipid Emulsion**

The lipid emulsion of SmofKabiven NTense® is composed of SMOFlipid and has a particle size and biological properties similar to those of endogenous chylomicrons. The constituents of SMOFlipid, soya oil, medium-chain triglycerides, olive oil and fish oil, have except for their energy contents, individual pharmacodynamic properties.

Soya oil has a high content of essential fatty acids. The omega-6 fatty acid linoleic acid is the most abundant (approx. 55-60%). Alpha-linolenic acid, an omega-3 fatty acid, constitutes about 8%. This part of SmofKabiven NTense® provides the necessary amount of essential fatty acids.

Medium-chain fatty acids are rapidly oxidised.

Olive oil mainly provides energy in the form of mono-unsaturated fatty acids, which are much less prone to peroxidation than the corresponding amount of poly-unsaturated fatty acids.

Fish oil is characterised by a high content of eicosapentaenoic acid (EPA) and docosahexaenoic acid (DHA). DHA is an important structural component of cell membranes, whereas EPA is a precursor of eicosanoids as prostaglandines, thromboxanes and leukotrienes.

Two studies providing home parenteral nutrition in patients in need of long-term nutrition support have been performed. The primary objective in both studies was to show safety. Efficacy was the secondary objective in one of the studies, which was done in paediatric patients. This study was stratified by age groups (1 month - < 2 years, and 2-11 years respectively). Both studies showed that SMOFlipid has the same safety profile as the comparator (Intralipid 20%). Efficacy in the paediatric study was measured by weight gain, height, body mass index, pre-albumin, retinol binding

## **NEW ZEALAND DATA SHEET – SMOFKABIVEN NTENSE® (AMINO ACIDS 6.5%, ELECTROLYTES 0.7%, LIPIDS 2.9% and GLUCOSE 8.5%)**

---

protein and fatty acid profile. There was no difference between the groups in any of the parameters except the fatty acid profile after 4 weeks treatment. The fatty acid profile in the SMOFlipid patients revealed an increase in omega-3 fatty acids in plasma lipoproteins and red blood cells phospholipids and hence reflects the composition of the infused lipid emulsion.

### **Amino Acids and Electrolytes**

The amino acids, constituents of protein in ordinary food, are utilised for tissue protein synthesis and any surplus is channelled to a number of metabolic pathways. Studies have shown a thermogenic effect of amino acid infusion.

### **Glucose**

Glucose should have no pharmacodynamic effects apart from contributing to maintain or replete the normal nutritional status.

### Clinical Trials

A randomised clinical trial had been conducted with SmofKabiven, which is a product with the same qualitative composition as SmofKabiven NTense®.

In the clinical trial 03-3CB7-001, 53 subjects who had undergone major intestinal surgery were randomised to receive either SMOFKabiven (n=26) or Kabiven G19% (n=27) for 5 – 7 days as TPN. The majority of subjects received at least five study infusions: 19 (73.1%) of the SMOFKabiven group and 18 (66.7%) of the Kabiven G19% group. Twenty five (96.2%) of the SMOFKabiven group and 23 (85.2%) of the Kabiven G19% group experienced at least one adverse event (AE). The most frequent AEs were gastrointestinal (nausea, flatulence and vomiting) and hypertension. Most events were mild to moderate in severity, with 17 subjects in the SMOFKabiven group and 11 subjects in the Kabiven G19% group experiencing AEs which were considered to be possibly or probably related to the study drug. Serious AEs (SAEs) occurred in five subjects in the SMOFKabiven group and two subjects in the Kabiven G19% group. All SAEs were judged to be unrelated to the study medication; being considered related to concomitant medication and the abdominal surgery the subjects had undergone. No clinically significant changes in vital signs were recorded. No drug related serious AE was observed in the study. The majority of reported AEs were mild with 14/26 in the SMOFKabiven group and 17/27 in the control group or moderate 19/26 and 10/27 respectively. Four patients in each group experienced at least one severe AE, however an unlikely relationship to the study drugs were found in the majority of patients in each group. One patient in the study group experienced an AE probably related to the study drug (nausea). A higher number of subjects experienced AEs that were possibly study drug related in the SMOFKabiven group with symptoms like nausea, vomiting and flatulence, which also are common postoperative symptoms after major abdominal surgery.

## **5.2 Pharmacokinetic Properties**

### Lipid Emulsion

The individual triglycerides in SMOFlipid have different clearance rate but SMOFlipid as a mixture is eliminated faster than long chain triglycerides (LCT). Olive oil has the slowest clearance rate of the components (somewhat slower than LCT) and medium chain triglycerides (MCT) the fastest. Fish oil in a mixture with LCT has the same clearance rate as LCT alone.

# **NEW ZEALAND DATA SHEET – SMOFKABIVEN NTENSE® (AMINO ACIDS 6.5%, ELECTROLYTES 0.7%, LIPIDS 2.9% and GLUCOSE 8.5%)**

---

## Amino Acids and Electrolytes

The principal pharmacokinetic properties of the infused amino acids and electrolytes are essentially the same as for amino acids and electrolytes supplied by ordinary food. However, the amino acids of dietary protein first enter the portal vein and then the systemic circulation, while intravenously infused amino acids reach the systemic circulation directly.

## Glucose

The pharmacokinetic properties of infused glucose are essentially the same as those of glucose supplied by ordinary food.

## **5.3 Preclinical Safety Data**

### Genotoxicity

Preclinical safety studies with SmofKabiven NTense® have not been performed. However, preclinical data for SMOFlipid as well as amino acid and glucose solutions of various concentrations and sodium glycerophosphate reveal no special hazard for humans based on conventional studies of safety pharmacology, repeated dose toxicity and genotoxicity. No teratogenic effects or other embryotoxic injuries could be observed in rabbits with amino acid solutions and are not to be expected from lipid emulsions and sodium glycerophosphate when giving at the recommended doses as substitution therapy. Nutritional products (amino acid solutions, lipid emulsions, and sodium glycerophosphate) used in replacement therapy at physiological levels are not expected to be embryotoxic, teratogenic, or to influence reproductive performance or fertility.

In a test on guinea pigs (maximisation test) fish oil emulsion showed moderate dermal sensitisation. A systemic antigenicity test gave no indication of evidence of anaphylactic potential of fish oil.

SmofKabiven intravenous infusion (the intended route of administration), as well as intra-arterial, intra-muscular, paravenous and subcutaneous injections did not reveal any drug substance-related changes in rabbits. SmofKabiven is a product with the same qualitative composition as SmofKabiven NTense®.

### Carcinogenicity

No data available.

## **6. PHARMACEUTICAL PARTICULARS**

### **6.1 List of Excipients**

- Glycerol
- Egg lecithin
- dl-alpha-tocopherol
- Sodium oleate
- Sodium hydroxide (pH adjuster)
- Glacial acetic acid (pH adjuster)
- Hydrochloric acid (pH adjuster)
- Water for injections

# **NEW ZEALAND DATA SHEET – SMOFKABIVEN NTENSE® (AMINO ACIDS 6.5%, ELECTROLYTES 0.7%, LIPIDS 2.9% and GLUCOSE 8.5%)**

---

## **6.2 Incompatibilities**

SmofKabiven NTense® may only be mixed with other medicinal products for which compatibility has been documented – see **Section 4.2 Dose and method of administration, “Compatibility”**.

## **6.3 Shelf Life**

### Shelf Life of the Medicinal Product as Packaged for Sale

2 years.

### Shelf life After Mixing the Contents of the Three Chambers

Chemical and physical in-use stability of the mixed three chamber bag has been demonstrated for 36 hours at 25°C.

From a microbiological point of view the product should be used immediately. If not used immediately, in-use storage times and conditions prior to use are the responsibility of the user and would normally not be longer than 24 hours at 2-8°C.

### Shelf Life after Mixing with Additives

From a microbiological point of view, the product should be used immediately when additions have been made. If not used immediately, the in-use storage time and conditions prior to use are the responsibility of the user and should normally not be longer than 24 hours at 2-8°C.

## **6.4 Special Precautions for Storage**

Store below 25°C. Do not freeze. Store in overpouch.

*Shelf life after mixing the contents of the three chambers:* See Section 6.3.

*Shelf life after mixing with additives:* See Section 6.3.

## **6.5 Nature and Contents of Container**

The container consists of a multi-chamber inner bag and an overpouch. The inner bag is separated into three chambers by peelable seals. An oxygen absorber is placed between the inner bag and the overpouch. The inner bag is made of a multilayer polymer film, Biofine.

The Biofine inner bag film consists of poly(propylene-co-ethylene), synthetic rubber poly[styreneblock-(butylene-co-ethylene)] (SEBS) and synthetic rubber poly(styrene-block-isoprene) (SIS).

The infusion and additive ports are made of polypropylene and synthetic rubber poly[styreneblock-(butylene-co-ethylene)] (SEBS) equipped with synthetic polyisoprene (latex-free) stoppers.

The blind port, which is only used during manufacturing, is made of polypropylene equipped with a synthetic polyisoprene (latex-free) stopper.

### Pack Sizes

- 6 x 506 mL

# NEW ZEALAND DATA SHEET – SMOFKABIVEN NTENSE® (AMINO ACIDS 6.5%, ELECTROLYTES 0.7%, LIPIDS 2.9% and GLUCOSE 8.5%)

---

- 4 x 1012 mL
- 4 x 1518 mL
- 4 x 2025 mL
- 3 x 2531 mL

Not all pack sizes may be marketed.

## 6.6 Special Precautions for Disposal and other handling

### Instructions for Use

Do not use if package is damaged. Use only if the amino acid and glucose solutions are clear and colourless or slightly yellow and the lipid emulsion is white and homogenous. The contents of the three separate chambers have to be mixed before use, and before any additions are made via the additive port, please refer to Section 4.2 Dose and method of administration, Additives.

After separation of the peelable seals the bag should be inverted on a number of occasions to ensure a homogenous mixture, which does not show any evidence of phase separation. Please also refer to Appendix "SPECIAL HANDLING INSTRUCTIONS" for further handling instructions.

For single use only. Any mixture remaining after infusion must be discarded.

Excessive exposure to light and UV light should be avoided as peroxide formation may occur.

Any additions should be made aseptically.

### Disposal

Any unused medicinal product or waste material should be disposed in accordance with local requirement.

## 6.7 Physicochemical Properties

### Chemical Structure

Chemical structures are included for the glucose and the electrolyte components only.

The amino acid and the lipid components are large molecules and therefore structures for these are not included.

### **Glucose monohydrate**

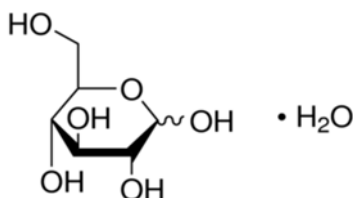

Empirical formula: 198.17 g/mol  
Molecular weight: C<sub>6</sub>H<sub>12</sub>O<sub>6</sub>·H<sub>2</sub>O

**NEW ZEALAND DATA SHEET – SMOFKABIVEN NTENSE® (AMINO ACIDS 6.5%, ELECTROLYTES 0.7%, LIPIDS 2.9% and GLUCOSE 8.5%)**

---

**Calcium chloride dihydrate**



Empirical formula:  $\text{CaCl}_2 \cdot 2\text{H}_2\text{O}$   
Molecular weight: 147.01 g/mol

**Magnesium sulfate heptahydrate**

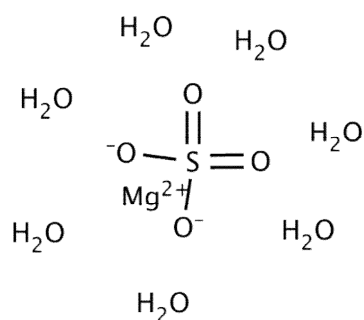

Empirical formula:  $\text{MgSO}_4 \cdot 7\text{H}_2\text{O}$   
Molecular weight: 246.47 g/mol

**Potassium chloride**

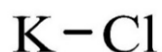

Empirical formula:  $\text{KCl}$   
Molecular weight: 74.55 g/mol

**Sodium acetate trihydrate**

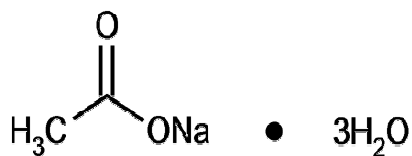

Empirical formula:  $\text{C}_2\text{H}_3\text{NaO}_2$   
Molecular weight: 136.08 g/mol

# NEW ZEALAND DATA SHEET – SMOFKABIVEN NTENSE® (AMINO ACIDS 6.5%, ELECTROLYTES 0.7%, LIPIDS 2.9% and GLUCOSE 8.5%)

## Sodium glycerophosphate hydrate

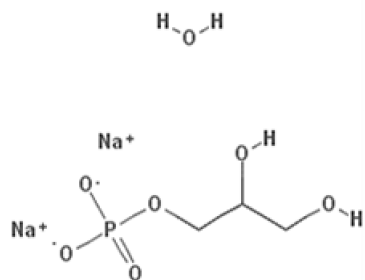

Empirical formula:  $C_3H_7Na_2O_6P$   
Molecular weight: 216.04 g/mol

## Zinc sulfate heptahydrate

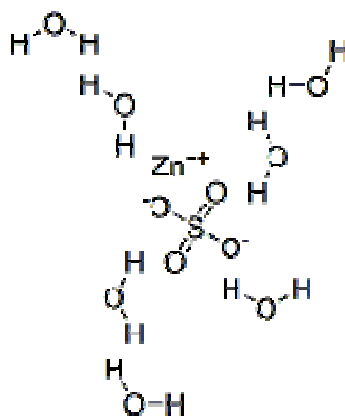

Empirical formula:  $ZnSO_4 \cdot 7H_2O$   
Molecular weight: 287.58 g/mol

## CAS Number

### ACTIVE SUBSTANCE

### CAS NUMBER

#### Amino Acids

Alanine	56-41-7
Arginine	74-79-3
Glycine	56-40-6
Histidine	71-00-1
Isoleucine	73-32-5
Leucine	61-90-5
Lysine acetate	57282-49-2
Methionine	63-683
Phenylalanine	63-91-2
Proline	147-85-3
Serine	56-45-1
Taurine	107-35-7
Threonine	72-19-5



# NEW ZEALAND DATA SHEET – SMOFKABIVEN NTENSE® (AMINO ACIDS 6.5%, ELECTROLYTES 0.7%, LIPIDS 2.9% and GLUCOSE 8.5%)

## ACTIVE SUBSTANCE CAS NUMBER

Tryptophan	73-22-3
Tyrosine	60-18-4
Valine	72-18-4

### Electrolytes

Calcium chloride dihydrate	10035-04-8
Magnesium sulfate heptahydrate	10034-99-8
Potassium chloride	7447-40-7
Sodium acetate trihydrate	6131-90-4
Sodium glycerophosphate hydrate	1334-74-3
Zinc sulfate heptahydrate	7446-20-0

### Lipids

Soya oil	8001-22-7
Fish oil - rich in Omega-3 acids	8016-13-5
Medium-chain triglycerides	73398-61-5, 65381-09-1
Olive oil	8001-25-0

### Glucose

Glucose monohydrate	5996-10-1
---------------------	-----------

## 7. MEDICINE SCHEDULE

General Sale Medicine.

## 8. SPONSOR

Fresenius Kabi New Zealand Limited,  
c/o GNZCC,  
HSBC Tower, Level 14, 188 Quay Street,  
Auckland 1010,  
New Zealand.  
Freecall: 0800 144 892

## 9. DATE OF FIRST APPROVAL

24 June 2021.

## 10. DATE OF REVISION

07 September 2021.

### Summary table of changes:

Section changed	Summary of new information
8, 9	NZ address and date of revision changed

# NEW ZEALAND DATA SHEET – SMOFKABIVEN NTENSE® (AMINO ACIDS 6.5%, ELECTROLYTES 0.7%, LIPIDS 2.9% and GLUCOSE 8.5%)

## SPECIAL HANDLING INSTRUCTIONS

### The bag

506 mL, 1012 mL, 1518 mL, 2025 mL, 2531 mL

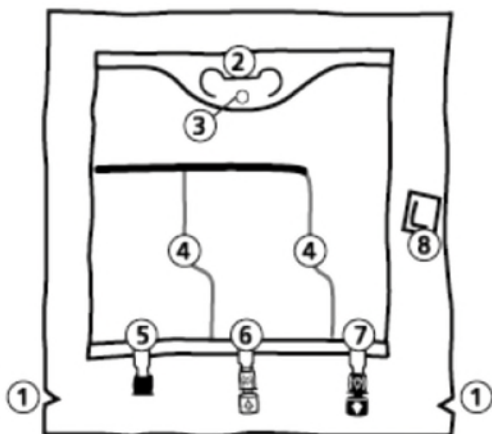

- ① Notches in the overpouch
- ② Handle
- ③ Hole for hanging the bag
- ④ Peelable seals
- ⑤ Blind port (only used during manufacturing)
- ⑥ Additive port
- ⑦ Infusion port
- ⑧ Oxygen absorber

### 1. Removal of Overpouch

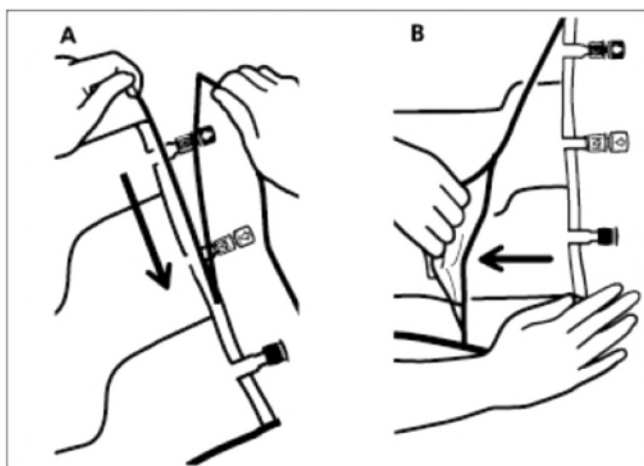

- To remove overpouch, hold the bag horizontally and tear from the notch close to the ports along the upper edge (A).

## **NEW ZEALAND DATA SHEET – SMOFKABIVEN NTENSE® (AMINO ACIDS 6.5%, ELECTROLYTES 0.7%, LIPIDS 2.9% and GLUCOSE 8.5%)**

---

- Then simply tear the long side, pull off the overpouch and discard it along with the oxygen absorber (B).

### **2. Mixing**

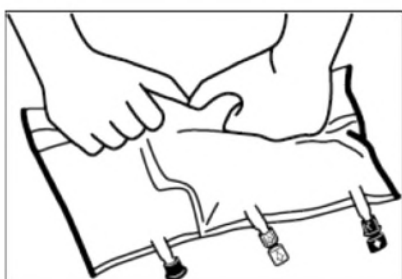
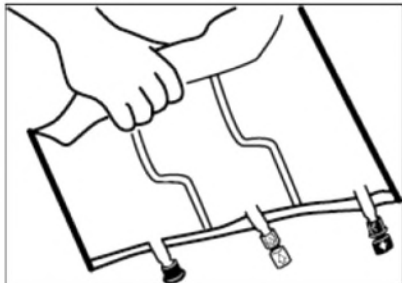

- Place the bag on a flat surface.
- Roll up the bag tightly from the handle side towards the ports, firstly with the right hand and then applying a constant pressure with the left hand until the vertical seals are broken. The vertical peel seals open due to the pressure of the fluid. The peel seals can also be opened before removing the overpouch.

**Please note:** The liquids mix easily although the horizontal seal remains closed.

506 mL, 1012 mL, 1518 mL, 2025 mL, 2531 mL

## NEW ZEALAND DATA SHEET – SMOFKABIVEN NTENSE® (AMINO ACIDS 6.5%, ELECTROLYTES 0.7%, LIPIDS 2.9% and GLUCOSE 8.5%)

---

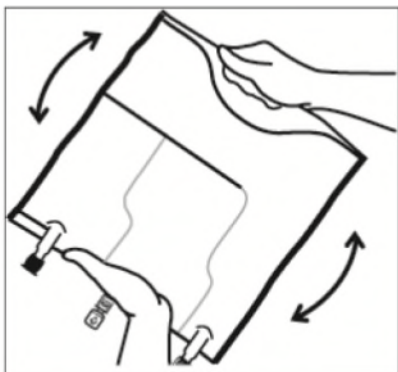

- Mix the contents of the three chambers by inverting the bag three times until the components are thoroughly mixed.

### 3. Finalising the Preparation

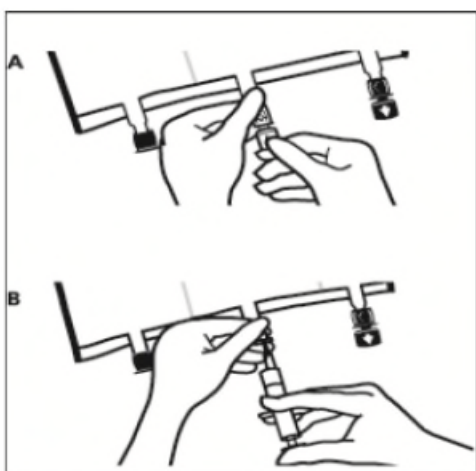

- Place the bag on a flat surface again. Shortly before injecting the additives, break off the tamper-evident arrow flag from the white additive port (A).

**Please note:** The membrane in the additive port is sterile.

- Hold the base of the additive port. Insert the needle, inject the additives (with known compatibility) through the centre of the injection site (B).
- Mix thoroughly between each addition by inverting the bag three times. Use syringes with needles of 18-23 gauge and a length of max. 40 mm.

## **NEW ZEALAND DATA SHEET – SMOFKABIVEN NTENSE® (AMINO ACIDS 6.5%, ELECTROLYTES 0.7%, LIPIDS 2.9% and GLUCOSE 8.5%)**

---

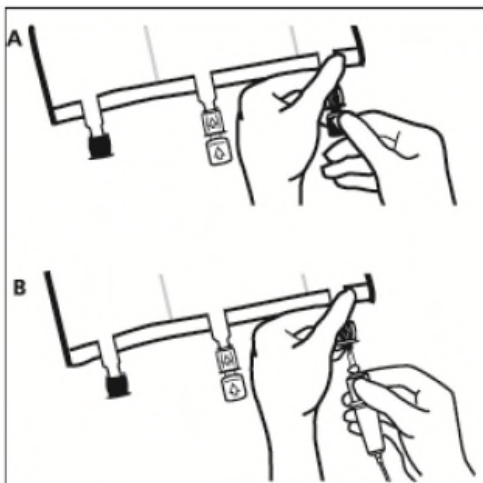

- Shortly before inserting the infusion set, break off the tamper evident arrow flag from the blue infusion port (A).

**Please note:** The membrane in the infusion port is sterile.

- Use a non-vented infusion set or close the air-inlet on a vented set.
- Hold the base of the infusion port.
- Push the spike through the infusion port. The spike should be fully inserted to secure it in place.

**Please note:** The inner part of the infusion port is sterile.

### **4. Hooking up the Bag**

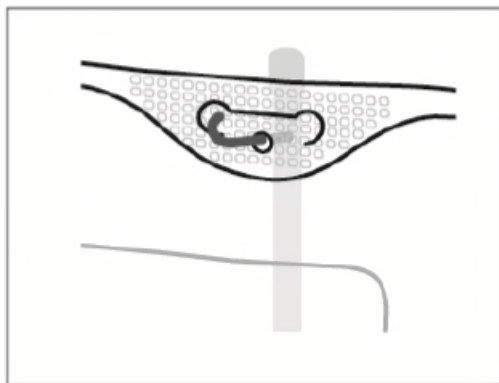

- Hook the bag up by the hole below the handle.